

PRODUCT SHEET

Description:

Sign Board Screw $\varnothing 19 \times 25$ mm, Brass, CPL, W/2 Transparent Washers

Item number:

22.11.050-0

Units	Box	Carton	HS Code	Barcode
Pcs.	60	240	8302490099	 5704866083997

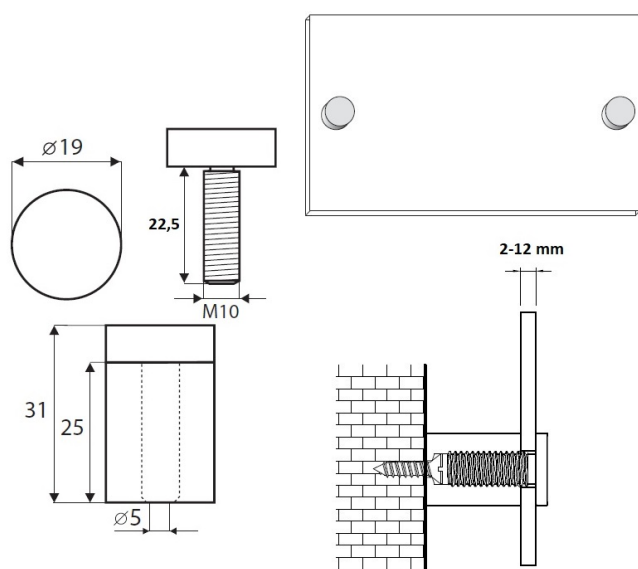

SISO A/S

Mileparken 11
DK-2740 Skovlunde
Denmark
VAT: DK 24786013

Phone +45 45 830 900

www.siso.dk
siso@siso.dk

Danske Bank
Nytorv Branch
Copenhagen
SWIFT: DABADKKK

Account no.
4180 3112 112936
IBAN Account
DK7230003112112936